



ASTROJET™ 2650P/2800P PRINTER



inkjet
technology by  [®]
invent

OPERATOR MANUAL

Astro Machine Corp.
630 Lively Blvd.
Elk Grove Village, IL 60007
Phone: (847) 364-6363
Fax: (847) 364-9898
www.astromachine.com

SAFETY PRECAUTIONS

THIS EQUIPMENT PRESENTS NO PROBLEM WHEN USED PROPERLY. OBSERVE SAFETY RULES WHEN OPERATING THE ASTROJET 2650P/2800P PRINTER.

BEFORE USING THE PRINTER, READ THIS MANUAL CAREFULLY AND FOLLOW THE RECOMMENDED PROCEDURES, SAFETY WARNINGS, AND INSTRUCTIONS:

- ✓ Keep hands, hair, and clothing clear of rollers and other moving parts.
- ✓ Avoid touching moving parts or materials while the machine is in use. Before clearing a jam, be sure machine mechanisms come to a stop.
- ✓ Always turn off the machine before making adjustments, cleaning the machine, or performing any maintenance covered in this manual.
- ✓ Use power cord supplied with unit and plug it into a properly grounded, easily accessible wall outlet located nearby. Failure to properly ground unit can result in severe personal injury and/or fire.
- ✓ Power cord and wall plug are the primary means of disconnecting unit from the power supply.
- ✓ **DO NOT** use an adapter plug on the line cord or wall outlet.
- ✓ **DO NOT** remove the ground pin from the line cord.
- ✓ **DO NOT** route the power cord over sharp edges or trap it between furniture.
- ✓ Avoid using wall outlets that are controlled by wall switches, or shared with other equipment.
- ✓ Make sure there is no strain on the power cord caused by jamming between equipment, walls or furniture.
- ✓ **DO NOT** remove covers. Covers enclose hazardous parts that should only be accessed by a qualified service representative. Report any cover damage to your service representative.
- ✓ Unit requires periodic maintenance.
Contact your authorized service representative for required service schedules.
- ✓ To prevent overheating, do not cover the vent openings.
- ✓ Use this equipment only for its intended purpose.

In addition, follow any specific occupational safety and health standards for your workplace or area.

This manual is intended solely for the use and information of Astro Machine Corp., its designated agents, customers, and their employees. The information in this guide was obtained from several different sources that are deemed reliable by all industry standards. To the best of our knowledge, that information is accurate in all respects. However, neither Astro Machine Corp. nor any of its agents or employees shall be responsible for any inaccuracies contained herein.

AstroJet™ is a registered trademark of Astro Machine Corp.
Hewlett-Packard is a registered trademark of Hewlett-Packard Corporation.
Windows 98, 2000 and XP are registered trademarks of Microsoft Corporation.
IBM is a registered trademark of International Business Machines.
All other trademarks are the property of their respective holders.

All rights reserved. No part of this book may be reproduced or transmitted in any form or by any means, electronic or mechanical, including photocopying, recording, or any information storage and retrieval system, without permission in writing from the publisher

Table of Contents

SECTION 1 – <i>Getting Acquainted</i>	1
SECTION 2 – <i>Installing Printer</i>	5
Connecting Printer	5
Connecting to Computer	5
Install Inkjet Cartridges	6
Setting up Feed	6
Installing Printer Driver	7
SECTION 3 – <i>Operating Printer</i>	9
Printer Operation	9
Purge While Printing	11
Printer Driver Properties	11
Printing from Microsoft Word	15
SECTION 4 – <i>Maintenance</i>	17
Inkjet Cartridge	17
Cleaning Printhead	18
Jams in Printer	19
Replacing Sheet Separators	19
Replacing Feed Rollers	20
Cleaning	21
Feed Rollers and Forwarding Rollers	21
Cleaning Media Sensor	21
SECTION 5 – <i>Troubleshooting Guide</i>	23
HP Inkjet Print Cartridges	23
Printer	24
APPENDIX A – <i>Specifications</i>	25
APPENDIX B – <i>Supplies and Optional Hardware</i>	26
Supplies	26
Optional Hardware	26
INDEX	27

SECTION 1 – *Getting Acquainted*

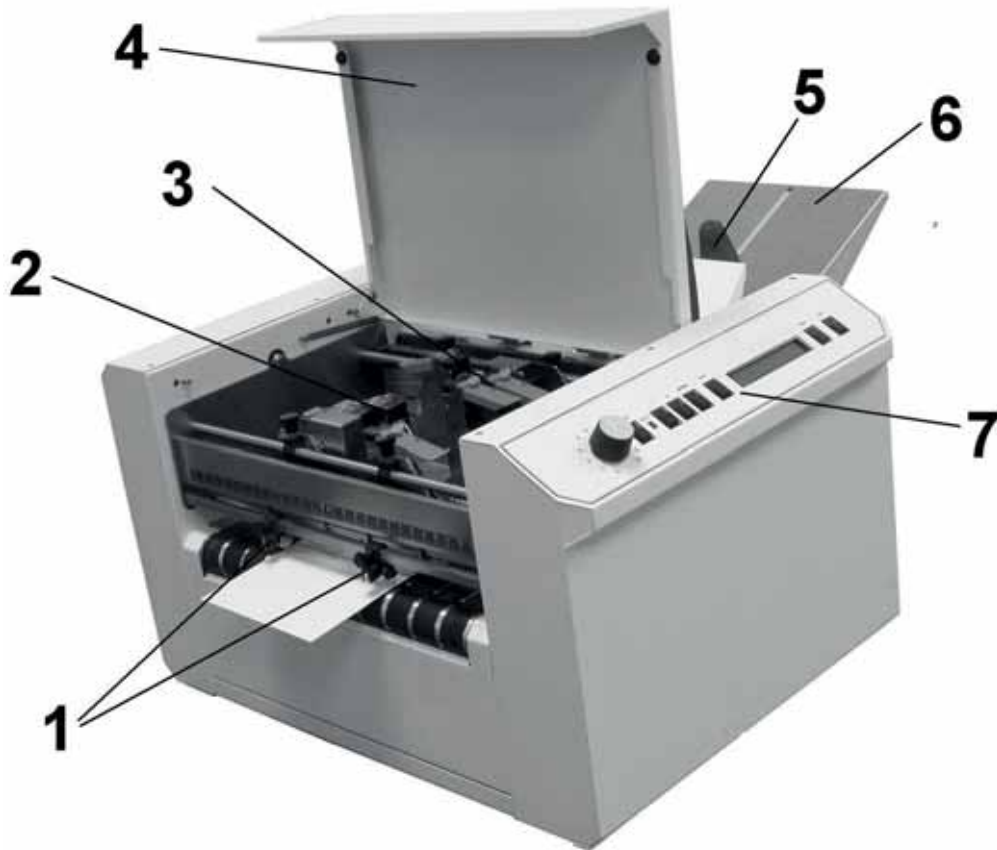

Operator View

1.	Exit Guides – Help media to exit Printer.
2.	Printhead Assembly – AstroJet 2650P has six Printheads arranged on two rails and can print an image up to 3" wide. AstroJet 2800P has eight Printheads arranged on two rails and can print an image up to 4" wide.
3.	Media Sensor – Located behind Printhead Assembly.
4.	Safety Cover – Encloses the Printheads.
5.	Rear Media Guide – Holds media against Front Plate.
6.	Rear Media Support – Supports media while it is being fed.
7.	Control Panel – Used to operate Printer. Knob is media thickness control.

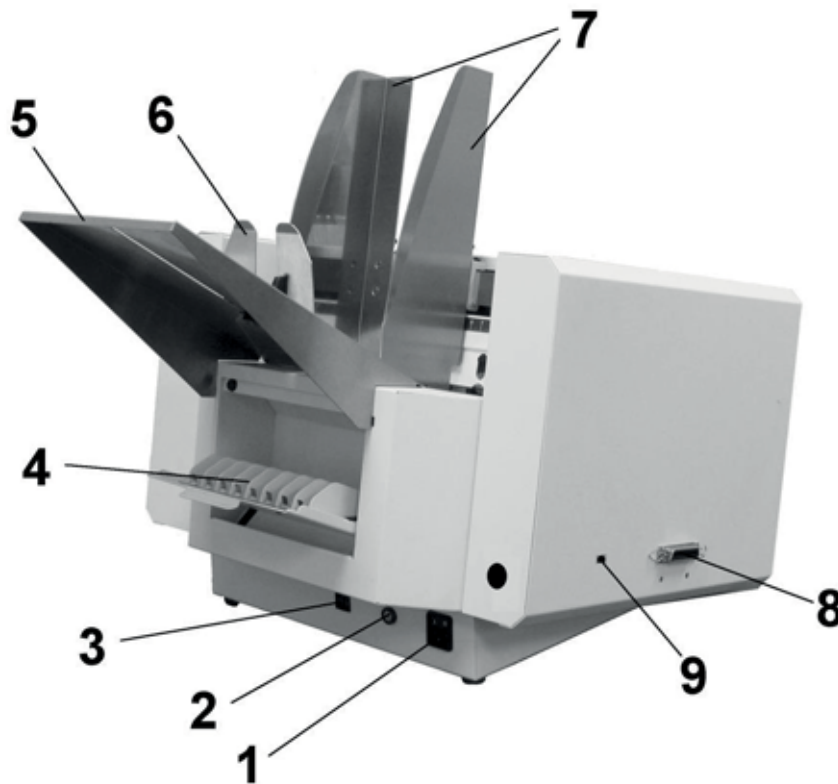

AstroJet 2650P Shown

Rear View

1.	Main Power Switch and Power Receptacle – Power cord plugs in here. Switch turns Printer ON and OFF.
2.	Main Power Fuse – Protects all electronic circuits in Printer.
3.	Motor Circuit Breaker – Protects Motor from overloads.
4.	Cartridge Docking Station – Stores Ink Cartridges when not in use.
5.	Rear Media Support – Supports media while it is being fed.
6.	Rear Media Guide – Holds media against Front Plate.
7.	Side Guides – Position media in Printer.
8.	Parallel Port – Connects Printer to Parallel Port on your computer.
9.	USB Printer Port – Connects Printer to your computer using USB Port.

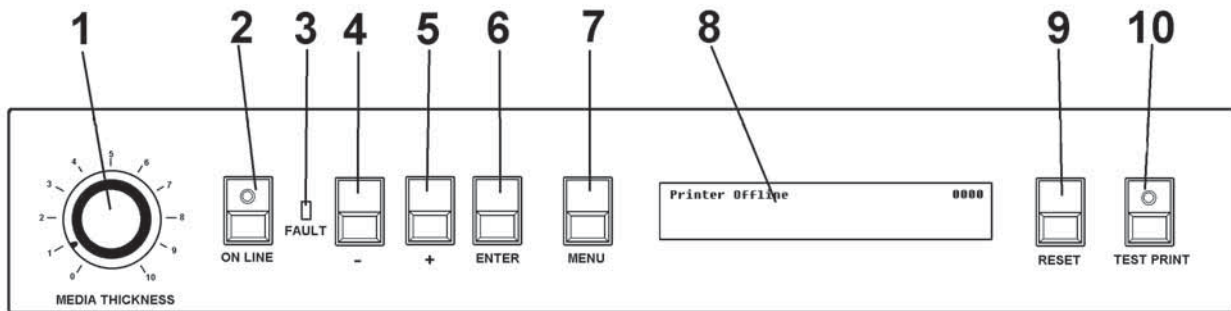

Control Panel

1.	MEDIA THICKNESS CONTROL – Adjusts height of Printheads to compensate for different media thicknesses.
2.	ON LINE key – Indicator lights when data is sent to Printer and printing is ready to begin. Also turns Printer offline to access Menu mode.
3.	FAULT Indicator – Lights when there is a problem with printing process.
4.	- key – In Menu mode, use this key to scroll to previous selection.
5.	+ key – In Menu mode, use this key to scroll to next selection.
6.	ENTER key – Starts and stops printing.
7.	MENU key – Puts Printer in Menu mode to access several operator functions.
8.	OPERATOR DISPLAY – Shows Printer's status, including menus and error messages.
9.	RESET key – Resets Printer to its "wait" state.
10.	TEST PRINT key – Puts Printer in Test mode and prints a sample copy to check Printer's output.

NOTE: A complete description of functions and operation of Printer Keys is found in Section 3 – Operating the ASTROJET 2650P/2800P.

SECTION 2 – *Installing Printer*

Before using Printer:

- Choose a location for Printer
- Plug in Printer and connect it to computer
- Install Inkjet Cartridges
- Set up feed on Printer
- Install Printer Driver software on computer

Choose a Location

Printer should be placed on a sturdy worktable or cabinet at least 12 inches from any walls. Protect Printer from excessive heat, dust, and moisture – avoid placing it in direct sunlight.

Connecting Printer

Plugging in Printer

Make sure that Printer Main Power Switch is turned OFF.

1. Connect one end of power cord into to rear receptacle on Printer.
2. Depending on 115 volt or 220 volt, plug other end into a 115 or 220 Volt AC, 50/60 Hz. grounded outlet.

CAUTION

DO NOT USE ADAPTER PLUGS OR EXTENSION CORDS TO CONNECT THE PRINTER TO THE WALL OUTLET.
DO NOT USE OUTLETS CONTROLLED BY WALL SWITCHES.
DO NOT USE OUTLETS THAT SHARE THE SAME CIRCUIT WITH LARGE ELECTRICAL MACHINES OF APPLIANCES.

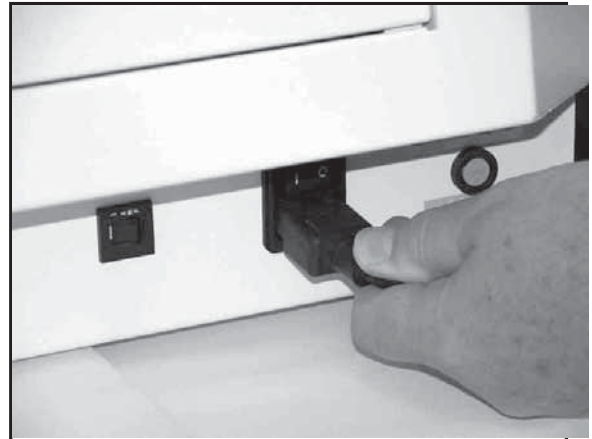

Connecting to Computer

Parallel Port: Plug Parallel Printer Cable from your computer into rear receptacle on Printer. Latch two locking clips.

USB Port: Connect Printer through a USB connection if using Windows ME, 2000, NT, or XP. **Cable used to connect the Printer to computer must not exceed 6 feet long.**

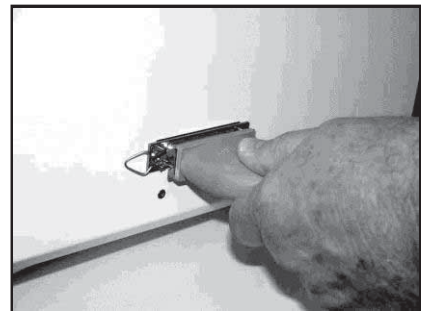

SECTION 2 INSTALLING THE PRINTER

Install Inkjet Cartridges

AstroJet 2650P can be configured with six Inkjet Cartridges.

AstroJet 2800P can be configured with eight Inkjet Cartridges.

To install Inkjet Cartridges:

1. Remove Inkjet Cartridge from packaging, taking care not to touch copper contacts, metal plate, or gold printhead. Remove protective tape from Printhead.
2. Open Latch Lever mounted on Inkjet Cartridge Holder.
3. With Cartridge's Printhead pointing down, slide Cartridge into Holder. Push down and toward contacts in Holder.

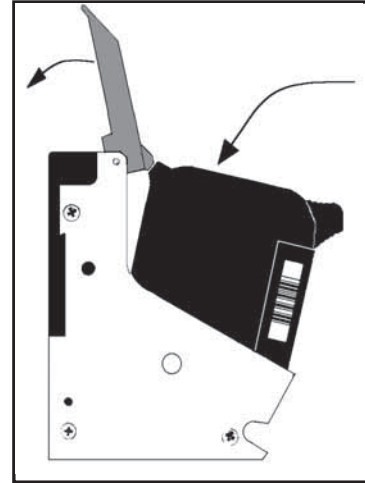

4. Make sure Cartridge is seated in Holder, then close Latch Lever to secure Cartridge. **DO NOT** force Latch Lever into place. (See diagram.)
5. Repeat **Steps 1-4** for remaining Inkjet Cartridges.

NOTE: For optimum image quality during the run, refer to "*Cleaning the Printhead*".

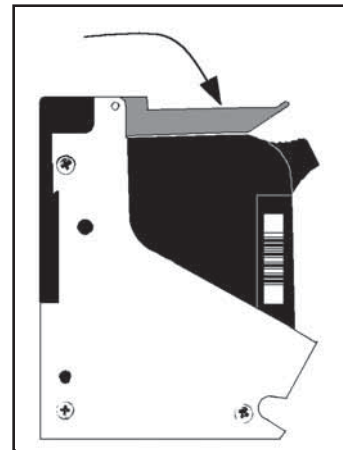

Ink in the cartridge may be harmful if swallowed. Keep new and used cartridges out of reach of children. Discard empty cartridges immediately.

Setting up Feed

1. Release Separator Locking Levers (*located on operator's side of Feeder*), then raise Separators to "up and locked" position. Move Side Guides to outermost open position. Place one piece of media in center of Feed Table.
2. **Four Separators on Feeder.** Use two Center Separators for narrow media and all four Separators for wide media. Place media under the Separators and lower Separators so that they rest on media.
3. Rotate Locking Lever up to lock Separators in place.

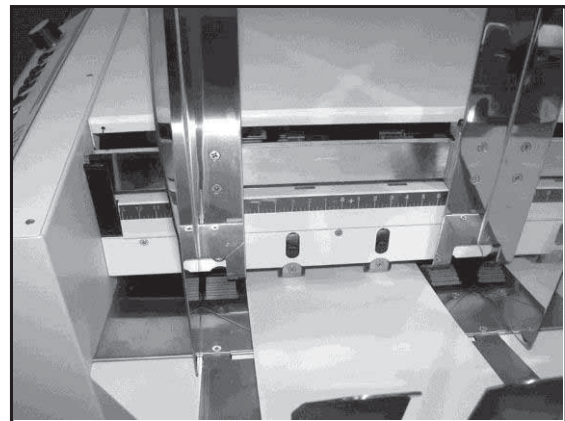

4. Loosen knobs on Side Guides. Adjust Side Guides to within 1/32" of media. Tighten knobs.
5. Adjust Rear Guide so that media is raised about 1/2" and rests on curve of Rear Guide. When running 10" or longer or heavy media you may have to set RearGuide so that it just touches back of media.

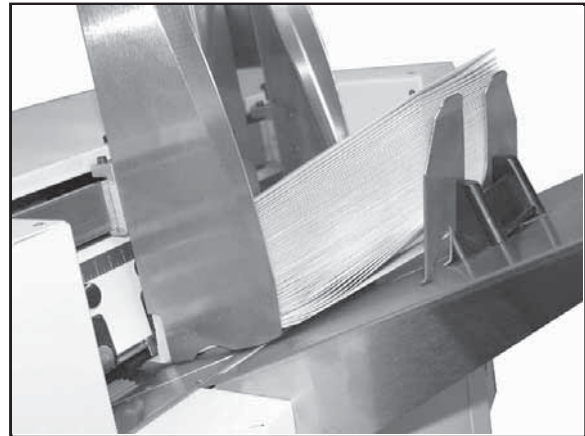

6. Feed a piece of media through Printer and adjust two Exit Guides so that they ride on media. To prevent smearing, make sure that Exit Guides do not track over any printed information.

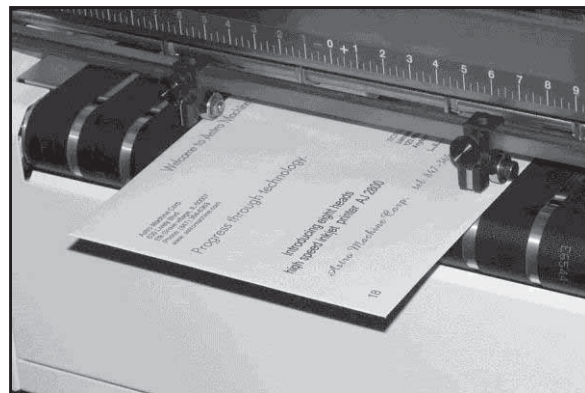

7. Turn Printer ON, then turn Media Thickness knob to set initial Printhead height as follows:

NOTE: These are initial settings. It may be necessary to adjust MEDIA THICKNESS Control to optimize print quality.

Media Thickness	Dial Setting
0.004" to 1/32"	0 to 2
1/32" to 1/8"	2 to 3
1/8" to 5/16"	3 to 7
5/16" to 3/8"	7 to 10

8. Press **ON LINE** key. Then press **ENTER** to test-feed media.

Installing Printer Driver

Printer Driver (*included*) must be installed on your computer before installing AstroPrint Software.

Install Driver for the Printer:

1. Close any applications running on your computer. Restart computer before installing Driver.
2. Install the CD in the CD drive and click **START**. Then click **RUN**, then type the following:
D:\Setup.exe (where D is the CD drive). Click **OK**.

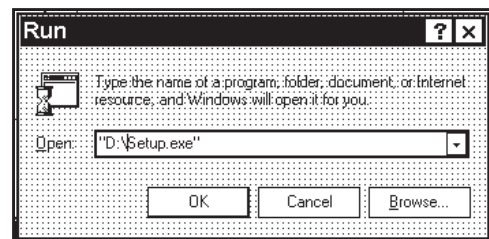

SECTION 2 INSTALLING THE PRINTER

3. “Add Printer Wizard (*n.nn*)” window opens. Click **N**ext>.
4. Type in your Name and Company. Click **N**ext>.
5. Select printer port **LPT1**. Then click **N**ext>. “Add Printer Wizard” appears. Select your printer from the table below, then click **N**ext>

Printer	Driver
AJ 2650P	AstroJet 2650
AJ 2800P	AstroJet 2800

6. Next screen allows you to “Name Your Printer”. Unless you have another printer of the same name on your system or network ignore this step and click **N**ext>.
7. Click **F**inish to complete installation.

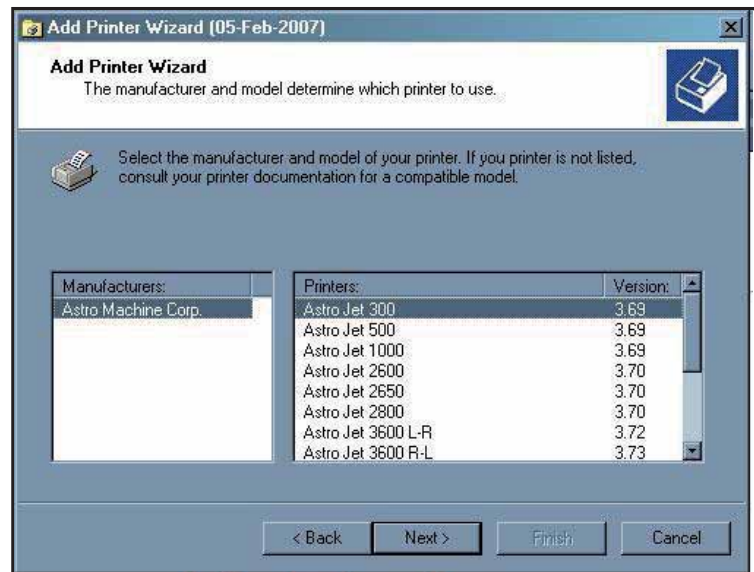

SECTION 3 – *Operating Printer*

Once the **Printer Driver** is installed on your computer, you are ready to start printing. This section is divided into three parts. The first describes the function of the **Printer Control Panel**. The second section describes the **Driver Properties** and the various options available when you run a job. The third section describes how to **Set Up a Job to Print** from Microsoft Word.

The **Printer Driver** installed on your computer in **Section 2** should be set as the default driver. It will then be accessible through your applications such as Microsoft Word. Other types of applications and database management software will work in a similar manner using the ASTROJET 2650P/2800P Driver.

This Section further assumes that you have connected the ASTROJET 2650P/2800P to your computer.

Printer Operation

When Printer is first turned ON, **ON LINE** key light blinks. Display shows; **“Printer Offline / Enter for Paper Feed”**. **TEST** key light is OFF. In this mode, pressing **ENTER** starts the paper feeding, but no printing takes place.

To print, you must put Printer on-line, when you do, display changes to; **“Printer Online / Waiting for Data”**. In this mode, when a job is sent, Printer will be ready to print when **ENTER** is pressed.

The following is a description of the operation of Printer’s various menu options that let you customize operation of Printer to suit. Printer Control-Panel Keys are used to access various functions that help operator control Printer.

TEST key

Pressing **TEST** places Printer in **Test Print** mode. **“Working”** appears in lower half of display. Then display changes to **“Enter to feed”**. Pressing **ENTER** starts printing process and prints **Test Print**. To stop feeding, press **ENTER** again.

NOTE: If Printer is set to start automatically (see “MENU key” below), Printer starts printing Test Print once it is loaded without having to press ENTER. In this case, pressing ENTER stops paper feed.

To exit **Test Print** mode, press **TEST** again and Printer returns to its ready state.

Press and hold **TEST** to make Printer to enter **“Service Menu”** where various Printer functions can be tested. To exit **“Service Menu”**, press **TEST** a second time. **“Service Menu”** is used primarily by service to diagnose problems should they occur. Use “+” or “-” keys to scroll through menu. Pressing **ENTER** tests the function.

To check Ink Cartridge ink levels when you enter **“Service Menu”**, press “-” key and amount of ink remaining will appear as a percentage in lower half of display window.

MENU key

Used to access special features built into Printer and to customize Printer operation. Basic features are accessed by pressing **MENU**. Use “+” or “-” keys to access features.

Features available under this mode of operation:

NOTE: If ON LINE key is ON, you cannot enter Menu mode.

Take Printer off line by pressing ON LINE key.

Media Thickness Setup – First item to appear in display is **“Media Thickness Setup”** (if Printer is equipped with an **Automatic Media Thickness Control**).

Use this feature to preset Printhead height for various media thickness.

SECTION 3 OPERATING THE PRINTER

Press Enter to Purge – Purging is useful in clearing Printhead Nozzles when Printer has been sitting idle for a time. To activate **Purge**, press **ENTER** to feed one piece of media. To purge Printheads additional times, press **ENTER** for each additional purge.

NOTE: Printer only purges one piece each time you press ENTER. For additional purges, press ENTER once for each subsequent purge.

Clear Batch Counter – Pressing **ENTER** clears number in upper right hand corner of display. Resetting Counter is usually performed at start of each job. Turning Printer OFF does not reset this Batch Counter.

Purge First Piece – Turning feature ON causes Printer to send one purge pattern on first piece. After purge is completed, next piece will be first record of your database. Once this feature is turned ON it remains ON even if Printer is turned OFF.

Address Recovery – In event of a Printer jam, recover up to 10 pieces by pressing **MENU**, then stepping to “**Address Recovery**”. Then press **ENTER**. “**Enter: Recover 1 Piece**” appears. Use “+” key to select number of pieces to reprint (1-10), then press **ENTER** again to start printing process. Once pieces are printed, press **ON LINE** key, then **ENTER** to resume printing job.

Print Enhancement – Pressing “+” or “-” keys brings up this message. **Print Enhancement** is used when printing to ensure that Nozzles on Printhead stay open and prevent loss of descenders on letters such as “y” or “q” and accent marks that do not appear in every address. Pressing **ENTER** turns this function ON or OFF. Function stays activated until operator changes it again. Turning Printer ON and OFF does not affect setting.

NOTE: Print Enhancement times out after 100 seconds if no media is going through Printer. Once media starts printing, it will restart.

Automatic Feed – Turning feature ON causes Printer to start feeding once job is sent. If **ON LINE** key is ON, Printer starts feeding and printing automatically. To press **ENTER** to start printing process, turn this feature OFF. Turning Printer ON or OFF does not affect selection.

Pause Type: – Allows Printer to respond to a “break mark” set in database used in a given job. The “break mark” marks the end of a series within the database. For example, addresses with same postal code or after a set number of entries. There are two “**Pause Type:**” selections:

Feed Stop – Setting is for standalone desktop units not used in line with other mailing equipment. Printer stops feeding media for a set amount of time after it “sees” a “break mark”. This allows time for operator to pack or separate that set of printed pieces before next set starts. Use “+” or “-” keys to access this feature. Press **ENTER** to turn this function ON or OFF.

Conveyor Speed Up – This feature is used when Printer is used in line with other mailing equipment (*conveyors, tabbers, etc.*) When this feature is activated, Printer responds to “break mark” by sending a signal to conveyor to speed up momentarily. This creates an obvious gap between end of one set of pieces and beginning of the next. Use “+” or “-” keys to access this feature. Press **ENTER** to turn this function ON or OFF.

Installing New Printheads – Printer can tell you when a Printhead is running low on ink. To use this feature, press **MENU**. Use “+” or “-” keys to highlight “**Enter when head (n) is filled.**” Press **ENTER** and install a new Cartridge. Repeat for each Cartridge you install. When **ENTER** is pressed, display changes to “**Head (n) has a new cartridge**”. To check Cartridge ink levels, press and hold **TEST PRINT** until “**Service Menu**” appears. Use “+” or “-” keys to scroll to “**Service Menu: Ink Levels, 100%100%100%**”. This shows amount of ink left in Cartridge.

NOTE: Feature only works if Cartridges remain in original Head where they were installed. If you swap Cartridges from one Head to another, ink levels will not be accurate.

A second set of menus is available in display. To activate, press and hold **MENU** until “**Setup Menu**” appears. Step through these items with “+” or “-” keys.

Total Count – Displays total number of prints that have passed through Printer. Non-resettable.

BIOS Version – Press “+” key to display BIOS version.

Bulk Ink – Not used on this model printer. No provisions are made to install larger cartridges.

+ / - key

Used to step through options in various Menu Modes.

ON LINE key

If **ON LINE** key is ON, display shows “**Printer Online / Waiting for Data**” and light is lit. This means that Printer is ready to print the job when it is sent. To have Printer start printing immediately when job is sent, **Automatic Feed** feature must be turned ON. If **ON LINE** key is OFF, display shows “**Printer Offline / ENTER for Paper Feed**”. Printer can then feed paper. Useful for setting up Feeder.

NOTE: If Printer is off line and you send a job, display shows “Printer Offline / Data Ready to Print”. To print, you must first press ON LINE key to put Printer online. If you sent data and Printer is set up to not start feeding automatically and ON LINE key is lit, display shows “Printer Online / ENTER to Start Feed”.

ENTER key

Used to start Printer printing when it is on line and **Automatic Feed** is turned OFF. Additionally, when Printer is placed in any **Menu** modes, **ENTER** is used to choose available options.

RESET key

Used to clear Printer Memory and return it to “standby” state. Key only functions if Printer is off line.

Purge While Printing

To do the purge in the middle of a job:

Press **ONLINE** to pause current job.

Press **MENU**, then step to “**Press Enter to Purge**”.

Press **ENTER** to start purge. Press **ENTER** again to stop purge.

Press **ONLINE**, then **ENTER** to get back to normal printing.

Note. If paper jam occurs during the purge; after the purge, use Address Recovery to get back to normal printing. Otherwise you will lose records.

Printer Driver Properties

NOTE: References in this manual are to AstroJet 2650P Printer. They also apply to AstroJet 2800P Printer. Difference is that AstroJet 2650P Printer has six Printheads and AstroJet 2800P has eight Printheads.

Printer Driver describes to Printer how to print your job. It controls operation of Printer and allows you to send fixed and variable text and graphics to Printer. Within your data management software is a **Print** function. In that print function is a **Properties** button. It is through **Properties** that you control your Printer output. **Properties Window** is used to customize Printer output.

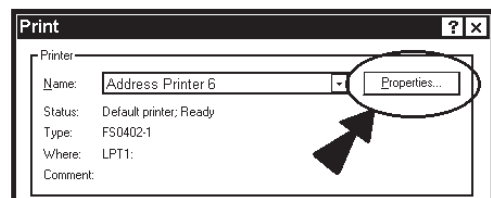

SECTION 3 OPERATING THE PRINTER

To start printing, click **F**ile, then **P**rint. “**P**rint” window opens. If you wish to print the job, click **O**K. To use special features built into Printer Drivers, clicking **P**roperties button opens **Properties** Window in Windows 98, 2000, XP, or ME.

If you are using Windows 2000 or XP, window at right opens. Clicking **A**dvanced opens “**O**ptions” window. In the following illustrations the windows for Windows 98, NT, and ME will be on the left. The windows for Windows 2000 and XP will be on the right.

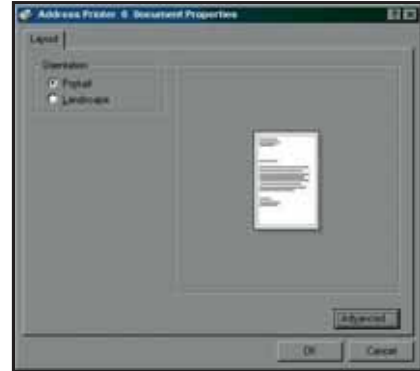

When **Properties** window opens you are presented with several tabs in Windows 95 and 98. The following are standard Windows Printer Driver functions and should be left at their defaults: **Graphics**, **Fonts**, and **Device Options**. The **Features** and **Print Heads** tabs are used to set up, change, and adjust Printer.

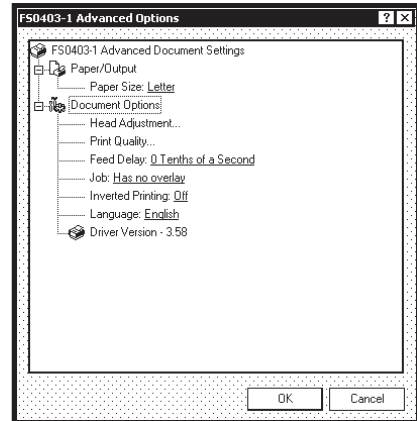

Features Tab

Features Tab/ Advanced Options, (depending on operating system), is used to change speed and resolution of Printer, to add a delay to the feed to provide separation between pieces, and to print and overlay with the job. First feature, **Print Quality**, has two settings: (1) for **Resolution** of print quality, (2) for appropriate **Speed**. Changing **resolution** to a higher number (e.g. 200 DPI to 600 DPI) increases image quality. When **resolution** is changed, **Belt speed** (IPS) is automatically changed to optimum speed for resolution selected.

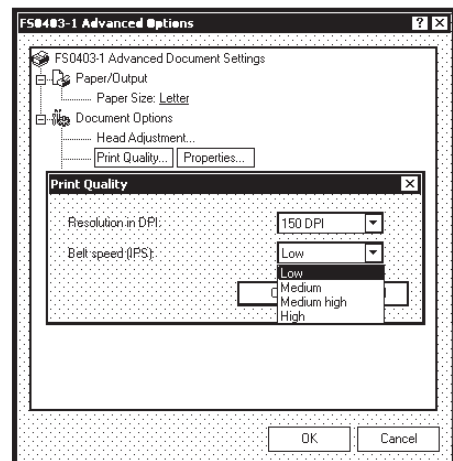
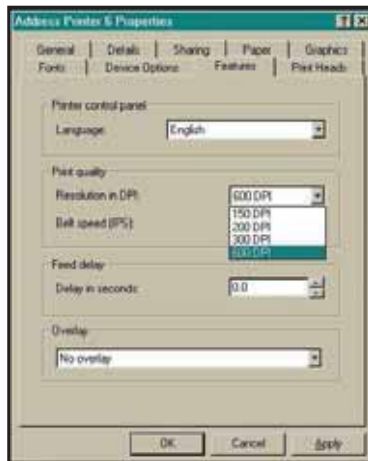

You can change speeds to a lower speed as follows:

Resolution	Speeds available
150 DPI	Low, Medium, Medium High, and High
200 DPI	Low, Medium, and Medium High
300 DPI	Low and Medium
600 DPI	Low

Feed Delay is used to add more space between pieces as they are printed. This allows first piece printed more time to dry before next piece is printed. Adjustment range is in 0.1-second increments. Feature works at all speeds.

Overlay is used to save time printing when combining a database with fixed information or graphics. Default is “**No overlay**”.

To use the **Overlay feature**, first create a layout in an application such as Microsoft Word. Place all fixed information and graphics on this layout. Open the layout and go to **Print** in **File** menu. Click **Features**, then click **Overlay**. Select “**Contains overlay**” from box, then click **Apply** and **OK**.

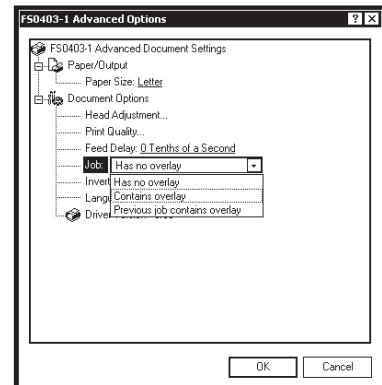

Now open the job that contains the variable data. Using **File**, then **Print** from dropdown menu, open “**Print**” window for application. Click **Properties**, then **Features** tab. Then click on dropdown menu under “**Overlay**” and click “**Previous job contains overlay**”. Click **Apply**, then **OK**. When “**Print**” window reappears, click **OK** to send job to Printer. To start printing, press **ENTER** on Printer.

If you wish to print a second job using same Overlay, simply open that job and send it to Printer. If next job does not contain an Overlay, then click **Properties** in “**Print**” window, select **Overlay**, then **No overlay**. Click **Apply**, then **OK**. To print next job with a different Overlay, repeat process for first Overlay.

NOTE: Turning Printer OFF, then ON clears Overlay and job.

Print Heads Tab

Permits slight (0.001") adjustments to positions of Printheads in relation to each other. Adjustment is used to align the three Printheads when printing graphics or type that extends beyond width of one Printhead. Each Head can be moved +/- 0.048" in 0.001" increments.

To move Printhead **toward** the lead edge of your layout, move it in the “-” direction.

To move Printhead **away** from the lead edge, move it in the “+” direction.

SECTION 3 OPERATING THE PRINTER

When Printer is turned OFF, any changes made this way return to original settings.

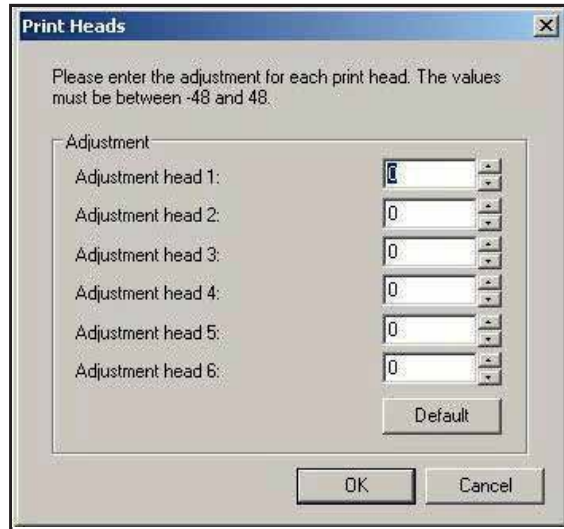

Inverse Printing

Paper tab contains one element that is used to reverse or invert the printing on Printer.

In normal operation, printing is read from operator side of Printer. It is sometimes necessary to turn printing direction 180 degrees from normal direction. This occurs when, due to layout or method of binding, media must be fed in reverse direction.

Clicking **Paper tab**, then **Paper Source** allows you to reverse printing direction 180 degrees.

Remaining settings on this tab should be left alone. **Paper size** is always “**Max Print Area**” and **Orientation** is always “**Portrait**”. Do not change them.

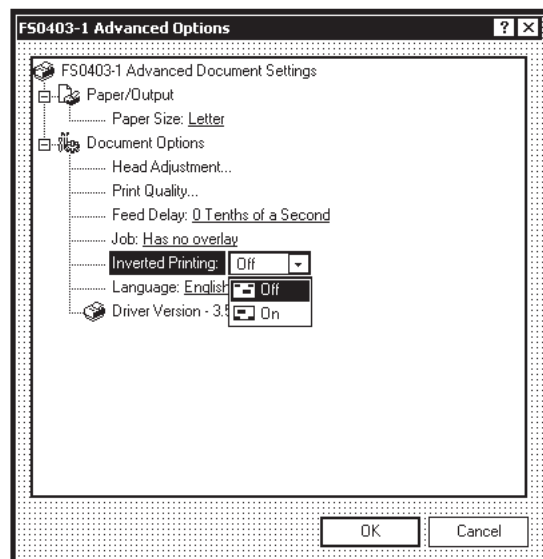
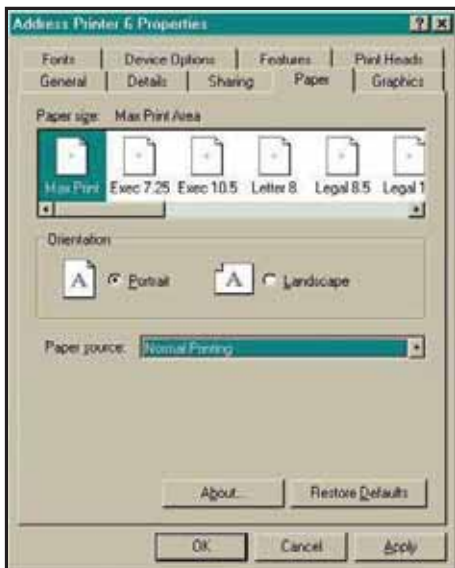

Printing from Microsoft Word

If you are not using a specific program designed for mailing applications it is possible to print your mail pieces using Microsoft Word. This section covers how to lay out a piece and to print from Microsoft Word.

To begin, open a new page and turn on toolbar for “Mail Merge”. Under “Print”, select **Address Printer 6** as default printer. Go to **Page Setup** in **File** menu. Set all margins to “0”.

NOTE: The Printer must be selected before you do the set up so that the setting will be registered.

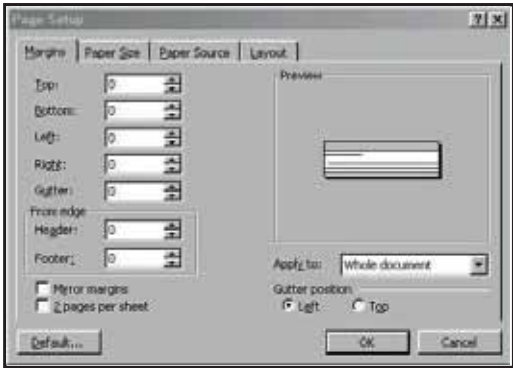

Next, select **Page Size** tab and **Custom Page**. Size of layout should be 3" high for the **AstroJet 2650P** or 4" high for the **AstroJet 2800P**, by the length of the piece you intend to print. (This example uses width of a #10 envelope, 9.5".) Orientation of piece is always **Portrait**. Effective printing area of **Astrojet 2650P** is 3" x 17" and 4" x 17" for **Astrojet 2800P**. Click **OK** when step is completed.

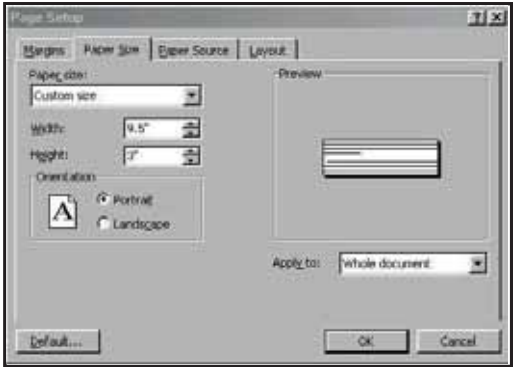

Next, create a text box so that you can position the address the proper distance from the lead edge of the piece. Once the page layout is set, you might want to save it as a template for use later.

When you have completed the steps above the layout for an **AstroJet 2650P** should look like the one below.

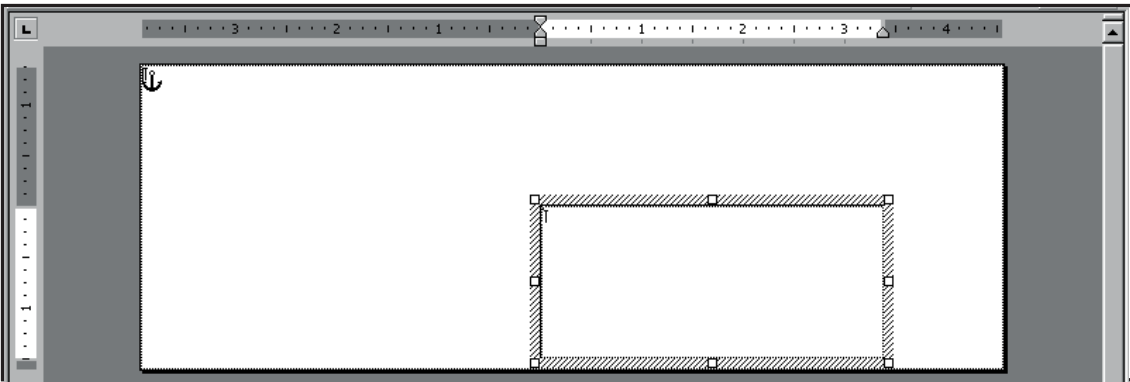

NOTE: When setting up a layout for the ASTROJET Printers, be aware that the Printheads are aligned in two banks on AJ2650P and these banks can be aligned so that you can print up to 3" wide. AJ2800 has four banks of Heads that permit a 4" wide print area on your media. Where you position the banks is dictated by the requirements of the job.

SECTION 3 OPERATING THE PRINTER

Click **T**ools, then **M**ail Merge. “Mail Merge Helper” window opens. Click **C**reate, then **E**nvelopes. “Microsoft Word” window opens. Click the **A**ctive Window button, then click the **G**et Data button.

Next, click **O**pen data source. Locate data file you intend to use. (*This example uses a Microsoft Excel file.*) Select the file. When the “Microsoft Excel” window opens, select entire spreadsheet and click **O**K.

Next, click **E**dit **M**ain Document. Click **C**lose.

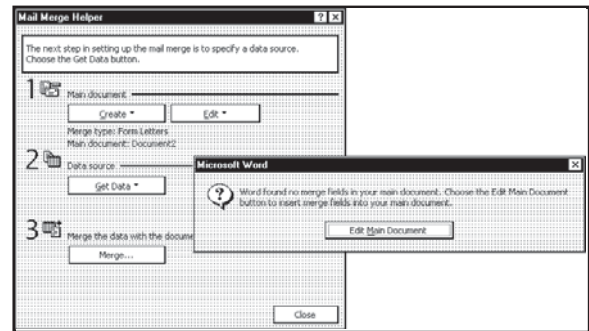

Use “Mail Merge” toolbar, click **I**nsert Merge Field, and begin to build layout by inserting address fields.

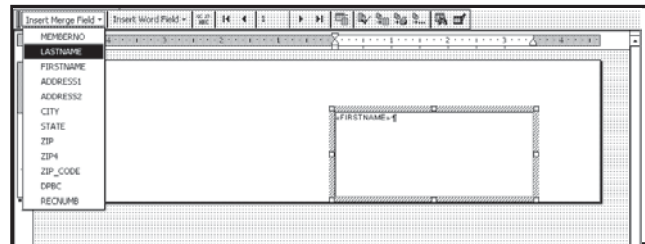

When you have completed setting up layout, click “Mail Merge” icon on toolbar and “Merge” window opens.

In “Merge to” menu, there are several choices for where and how data is exported. The two that concern us are “New Document” and “Printer”. If you choose “New Document”, merge is created in your word application with a separate record for each address. If you choose “Printer”, merge is sent directly to Printer and each record will be printed.

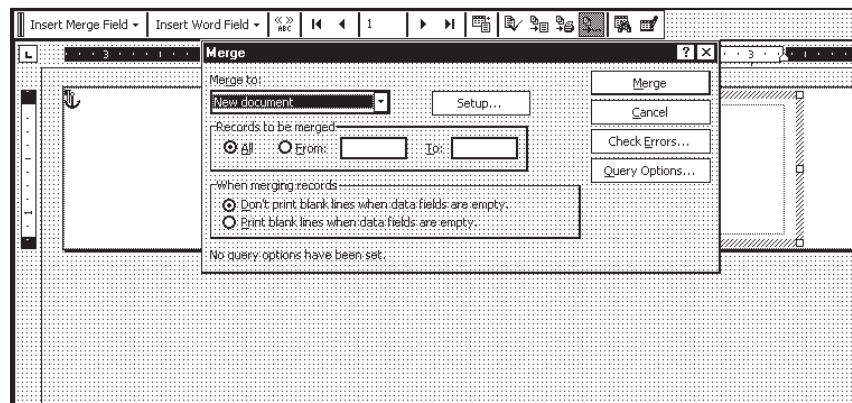

Next selection is “Records to be merged”. Select **A**ll or **F**rom.

Last selection is “When merging records”. Default is “Don't print blank lines when data fields are empty.” This should be left checked.

Clicking **M**erge starts merging the documents.

If you chose to send merge directly to Printer and Printer is connected to computer and turned ON, Printer will start. Pressing **E**NTER starts printing process.

If you have a graphic or fixed text to be printed with the data, refer to the section on **O**verlays.

SECTION 4 - *Maintenance*

This section covers how to care for the Ink Cartridges, clear paper jams, replace the Sheet Separators, and perform routine maintenance on the Printer.

Inkjet Cartridge

Inkjet Cartridges must be replaced when out of ink, when print quality is poor, or when purging and cleaning have not helped the image quality. Approximate life of the HP 45 Inkjet cartridges, based on three lines of 20 characters at 10-point size per address, is:

600 x 600 DPI	50,000 addresses
300 x 600 DPI	100,000 addresses
200 x 600 DPI	150,000 addresses
150 x 600 DPI	200,000 addresses

NOTE: These figures can vary depending on font selected.

To Replace Inkjet Cartridge:

1. Open Latch Lever to release Cartridge, then pull Cartridge up and out of Holder.
2. Remove new Inkjet Cartridge from packaging, taking care not to touch copper contacts, metal plate, or gold printhead. Remove protective tape from Printhead.
3. With Cartridge's Printhead pointing down, slide Cartridge into Holder and push down and toward contacts in Holder.
4. Make sure Cartridge is seated in Holder, then close Latch Lever to secure Cartridge. **DO NOT** force Latch Lever into place.
5. Repeat **Steps 1-4** for remaining Cartridges.

CAUTION

NEVER SHAKE, DROP, OR HIT THE CARTRIDGE AGAINST THE PALM OF YOUR HAND OR ANY OTHER HARD SURFACE. SHAKING THE PRINT CARTRIDGE DOES NOT "MIX" THE INK AND HITTING THE CARTRIDGE AGAINST A HARD SURFACE DOES NOT CLEAR THE NOZZLES. BOTH OF THESE ACTIONS ACTUALLY HURT PRINT QUALITY BECAUSE THEY ALLOW BUBBLES TO FORM NEAR THE INK FIRING CHAMBERS. THESE BUBBLES PREVENT THE NOZZLES FROM FIRING, CAUSING WHITE STREAKS IN THE PRINT IMAGE.

SECTION 4 MAINTENANCE

Storage

Short-term Storage (*less than 2 days or less than 1 day in a hot and dry environment*)

Leave Cartridge in Printer for short periods of time, 1 day or less.
Next time Printer is used, Printhead may have to be cleaned and purged.

Long-term Storage (*more than 2 days or more than 1 day in a hot and dry environment*)

Place Cartridges in Cartridge Docking Station located at rear of Printer, or

Place Cartridges in a sealable plastic container with a damp sponge or towel to maintain humidity and prevent Printhead from drying out.

When Cartridges are ready to be used again, Printhead will need to be cleaned.

Disposal

Cartridges may be disposed of in a normal manner.

In case of an ink spill, use soap and water to clean up any problem areas.
Abrasive soap usually removes ink off of hands.



Ink in the cartridge may be harmful if swallowed. Keep new and used cartridges out of reach of children. Discard empty cartridges immediately.

Cleaning Printhead

Maintain good print quality by keeping Printheads clean. During printing process ink spray, paper fibers, and dust can build up on Printheads. This build-up eventually degrades print quality. If you notice problems with print quality, or to just prevent a build-up from occurring, wipe Printhead with a wet fiberless cloth.

<i>Cloth should be:</i>	<i>Cloth should not be:</i>
<ul style="list-style-type: none">✓ Soft✓ Fiberless✓ Moistened with water (<i>Distilled is best but tap water will work</i>)	<ul style="list-style-type: none">✗ Abrasive✗ Made of small fibers✗ Dry or contain chemical additives

Wipe slowly across the long-axis with Printhead facing down (*as shown*). **DO NOT** apply excessive force, as this could scratch Nozzle area.



Purging the Nozzles

If the Printhead sits inactive for a period, ink may dry in the Nozzles. Printing may not remove these “ink plugs” from the Nozzles. White streaks will then show up in the printed text or graphic. In order to obtain better print quality, these ink plugs need to be forced out or purged. A **Purge** routine is built into the Printer. It can be accessed from the LCD Panel on the Printer from the **MENU** key.

If this does not solve the problem, proceed as follows:

1. Wipe Printhead with a wet cloth as described in “*Cleaning the Printhead*” above.
2. Perform **Purge** routine from Printer by pressing **MENU**, then “+” key. Load media and press **ENTER** to purge. Repeat if necessary.
3. Wipe Printhead again with a moist cloth.

NOTE: For more information, refer to Troubleshooting Printheads in Section 5 – Troubleshooting Guide.

Jams in Printer

If a jam occurs, **STOP the Printer**. Up to 10 missed addresses can be recovered at the Printer Control Panel. (See *Section 3 – Operating the Printer*, “Print Recovery After Jam”.

Some possible reasons for jamming are:

1. Feeding more than one piece of media.
2. Damaged media, such as dog-eared (*turned down corners*).
3. Media that is not stiff enough may not be usable. Media that meets Postal stiffness requirements for automated feeding is acceptable in the Printer.
4. Envelopes caught under the flap of another envelope or stuck to one another may cause jamming.

Removing Jammed Media

1. It may be necessary to move one or more Printheads to gain access to jammed media. Take care when removing jammed media to avoid damaging Printheads. All pieces of jammed media must be removed from the feed path.
2. Follow instructions in *Section 3 – Operating the Printer*, “Print Recovery After Jam”.

Replacing Sheet Separators

Sheet Separators insure separation of the pieces as they are being fed. They wear and must be replaced periodically. If you experience double sheet feeding and cannot adjust the Separators to prevent it, they should be replaced.

Replacement of the Sheet Separators is not difficult:

1. Turn OFF and unplug Printer.
2. Release Separator Locking Lever and move Media Side Guides to their maximum open position.
3. Lower the Separators so they touch the Feed Roller.
4. Remove screw [A] and Separator Support [B]. Then remove Separator [C] by prying it out of Holder.
5. Install a new Separator and reinstall Separator Support and screw.

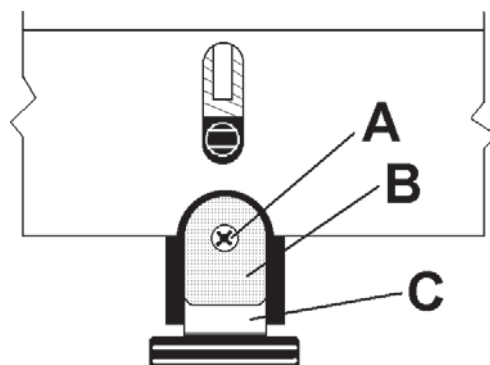

**SECTION 4
MAINTENANCE**

Replacing Feed Rollers

1. Before removing Feed Roller Access Plate, unplug power to Printer.
2. Use a Phillips screwdriver to remove three screws from Feed Roller Access Plate. Then remove Access Plate.

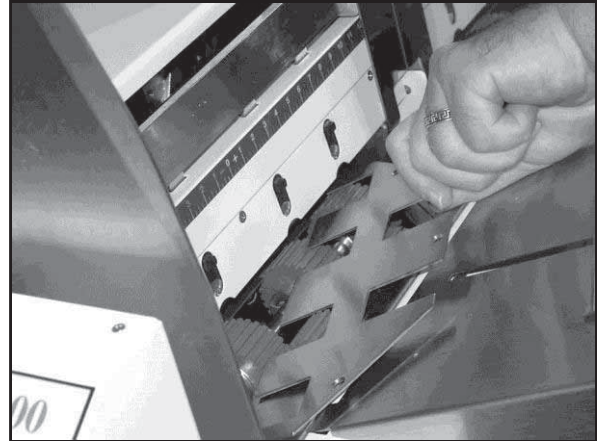
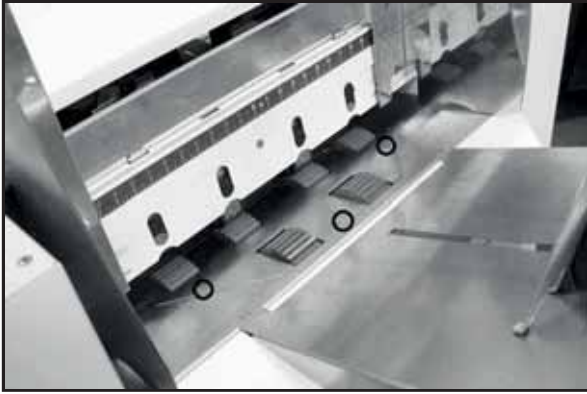

3. Determine which type of Roller (**A or B**) is installed on Printer.
(**Type B** replaced **Type A** which was installed Printers manufactured before May 2012.)
NOTE: All replacement Feed Roller Assemblies are type B. Type A is no longer available.

[A] Ridged tread, 2-pc. Feed Roller.

To Remove:

Rotate Feed Roller Shaft so Feed Roller mounting screws are face up.

Use a 3/32" Allen wrench to remove two button head cap screws. Remove one half of Feed Roller. Rotate shaft until two screws holding second half of Feed Roller are accessible. Remove those screws, then remove second half of Feed Roller.



[B] Smooth tread, 1-pc. Feed Roller.

To Remove:

Rotate Feed Roller Shaft so Feed Roller mounting screws are face up.

Use a 3/32" Allen wrench to remove

two button head cap screws. Rotate shaft until remaining two screws holding Feed Roller are accessible. Remove those screws, then open and remove Feed Roller.

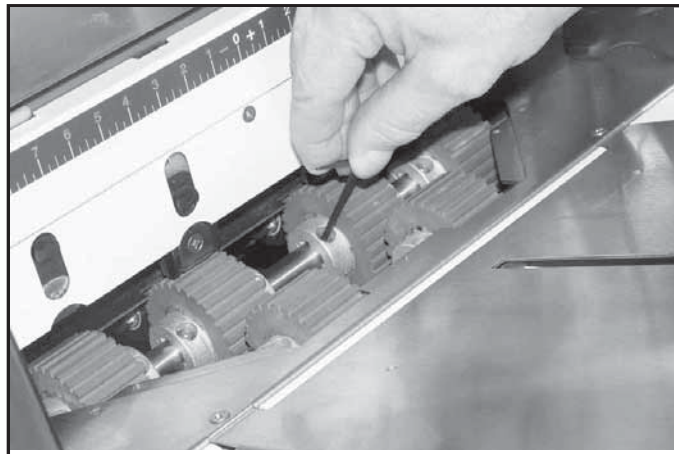
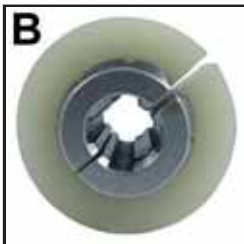

4. Fit new Feed Roller around Shaft, align holes and replace two screws. Rotate Shaft and reinstall remaining two screws.
5. Replace Feed Roller Access Plate and fasten with three Phillips screws.

Cleaning

WARNING!

PRINTER IS A PRECISION MACHINE THAT SHOULD BE CLEANED REGULARLY TO INSURE MANY YEARS OF SERVICE. BEFORE PERFORMING ANY MAINTENANCE, DISCONNECT PRINTER FROM ITS POWER SOURCE!

Printer must be cleaned regularly of accumulated paper dust and ink. Depending on types of media that are run, paper dust may accumulate within Printer and on Transport. To properly clean Printer, unplug it from the power receptacle and remove covers.

- **Internal Areas:** Best cleaned using a vacuum with a soft brush attachment to help loosen dust particles. Take care not to damage PC Boards or electrical wiring.
- **Exterior Areas:** May be cleaned with any standard non-abrasive household cleaner that does not contain plastic-harming solvents.

CAUTION

NEVER SPRAY OR POUR CLEANERS DIRECTLY ON OR INTO THE PRINTER. EXCESS LIQUID COULD HARM ELECTRONIC PARTS. ALWAYS DAMPEN A RAG WITH THE CLEANER AND APPLY IT TO THE PARTS TO BE CLEANED.

Feed Rollers and Forwarding Rollers

Feed and Forwarding Rollers can become glazed with paper lint and ink from media. They should be regularly cleaned with a mild abrasive household cleaner on a damp cloth.

Avoid using solvents on Rubber Rollers.

Cleaning Media Sensor

Periodically check Media Sensor located in Print Carriage area of Printer. Sensor should be clean and free of accumulated paper dust. Use a vacuum with a soft brush attachment or dry compressed air to remove dust.

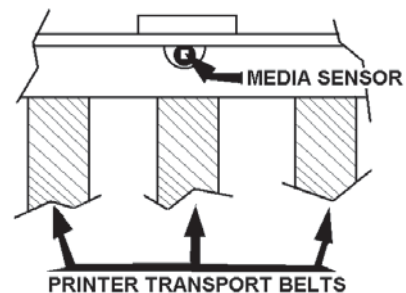

SECTION 5 – *Troubleshooting Guide*

Troubleshooting Guides are provided to assist you in solving any problems that might occur with Printer or its software. We tried to make them as complete as possible. The best advice we can offer is to make sure that the system is setup properly, plugged in, has an adequate supply of ink before attempting to troubleshoot any problem.

HP Inkjet Print Cartridges

CONDITION	PROBLEM	SOLUTION
Black streaks in text This is a sample of text showing black streaks in the copy.	Lint or paper dust on Printhead.	Clean Cartridge Nozzles with a clean lint-free cloth moistened with distilled water.
Cartridge will not print	Sheet is blank even after it has gone underneath Cartridge(s).	Check to make sure tape is off Printhead. Remove and reinsert Cartridge into Carriage Holder. Install new Print Cartridge.
White streaks in text or graphics Michael Jones Astro Machine Corp. 630 Lively Blvd. Elk Grove Village, IL 60007-1234	Lint or dust blocking Printhead holes. Poor contact between Printhead and Printhead Holder.	Clean Cartridge Nozzles with a clean lint-free cloth moistened with distilled water. Clean Interconnects. Remove and reinsert Cartridge into Holder. Insert new Print Cartridge.

Printer

CONDITION	PROBLEM	SOLUTION
Extra lines; losing data	Database problem	Check data in database program
Improper output (address information out of order, miss-feeding, etc.)	Wrong Interface settings Static electricity	Check software or database on PC. Close AstroJet Control Panel software, turn Printer OFF and ON. Clean Media Sensor.
	Dirty Media Sensor	
Media jams	Double feeding	Adjust Sheet Separators on Feeder.
	Media is curled or bent	Uncurl media.
	Media is too thin	Media must be at least 0.008".
No communication	Improper cabling / connector	Use proper cable (see <i>Operator Manual</i>).
	Unit not receiving power	Check plug connections, ON/OFF Switch and Fuse on Back Panel (see <i>Operator Manual</i>).
Not printing on media	Media not positioned properly	Adjust Printhead vertically. Adjust margin setting in layout software.
Print too light or missing character dots	Clogged or dirty Printheads Running out of ink	Purge or clean Cartridges. Replace Inkjet Cartridges.
Blurry address 	Image is not sharp	Printhead gap too high. Adjust Printhead closer to the media.
Split line of type Astro Machine Corp. 630 Lively Blvd. Elk Grove Village, IL 60007	Line of type is placed across two Printheads	Reposition text in layout so that it does not print across two Printheads. Adjust positioning of two Printheads in relation to each other using Head Alignment Tool in AstroJet Software Control Panel or in Properties window of PCL version Driver.
Uneven split line of type Astro Machine Corp. 630 Lively Blvd. Elk Grove Village, IL 60007	Some but not all of a line of type across two Printheads matches up	Reposition text in layout so that it does not print across two Printheads. Check Sheet Separator adjustment. Separators should just touch media. Check that Printhead is set at proper height. Printhead set too high will cause media to slip as it passes under Heads.

WARNING!

**DO NOT REMOVE SIDE COVERS ON PRINTER!
HIGH VOLTAGES PRESENT BEHIND COVERS!**

APPENDIX A – Specifications

PRINT TECHNOLOGY	AstroJet 2650P: 6 HP 45 High Capacity Inkjet Cartridges AstroJet 2800P: 8 HP 45 High Capacity Inkjet Cartridges
ADDRESS SPEED	Up to 26,000/hr - #10 Envelopes
PRINT QUALITY (Dots Per Inch)	High Quality 600 x 600 DPI Standard Quality 600 x 300 DPI Letter Quality 600 x 200 DPI Draft Quality 600 x 150 DPI
IMAGE AREA	AstroJet 2650P: 3" x 17" AstroJet 2800P: 4" x 17" (2800P)
PRINT ORIENTATION	Normal and Reverse
INK MONITOR	Visible on Display
FONTS	All TrueType fonts available on PC
PRINTS	Prints graphics, logos, and barcodes
MATERIAL SIZE	Length: 5" to 17" Width: 3" to 13.5"
MATERIAL THICKNESS	Up to 3/8"
FEEDER CAPACITY	Up to 750 #10 envelopes
MEMORY	64 MB
PRINT COLORS	Versatile Black and General Black, Red, Blue, Green, and Yellow
INK	Water-based, may require drying assistance for coated stock
SOFTWARE	Windows™ Printer Drivers for Windows™ 95, 98, 2000, NT, ME, and XP
DIAGNOSTICS	Resident in firmware
FIRMWARE UPDATE	Flash PROM update.
PC INTERFACE	Centronics Parallel and USB
COUNTERS	One operator resettable job counter, one permanent lifetime counter
DUTY CYCLE	60 million addresses total or 1,000,000 per month over a 5-year life cycle.
DIMENSIONS	25" H x 28" L x 22" W (635 mm H x 711 mm L x 559 mm W)
WEIGHT	80 lbs. (36.4 kg.)
ELECTRICAL	AstroJet 2650P/2800P: 115VAC or AstroJet 2650PE/2800PE: 240VAC, 50/60 Hz
OPTIONS	Conveyor/Stacker and Drop Tray

All Specifications Subject To Change Without Notice

APPENDIX B – *Supplies and Optional Hardware*

The following supply items and optional hardware are available from your Astro Machine Dealer:

Supplies

Red Inkjet Cartridge	HPC6168A
Green Inkjet Cartridge	HPC6169A
Blue Inkjet Cartridge	HPC6170A
Yellow Inkjet Cartridge	HPC6173A
Versatile Black	HPC8842A
General Black (<i>works on high gloss media when used with dryer</i>)	IQ2392

Optional Hardware

Conveyor / Stacker Available	
Drop Tray	

INDEX

- Key	3, 11		
+ Key	3, 11		
C			
Circuit Breaker, Motor	2		
Cleaning	21		
Feed Rollers	21		
Forwarding Rollers	21		
Media Sensor	21		
Printhead	18		
Connecting			
Computer	5		
Printer	5		
Control Panel	3		
- Key	3, 11		
+ Key	3, 11		
Display	3		
ENTER Key	11		
FAULT Indicator	3		
Media Thickness Control	3		
MENU Key	9		
ON LINE Key	3, 11		
Printer	1		
RESET Key	3, 11		
TEST Key	9		
TEST PRINT Key	3		
D			
Display, Control Panel	3		
Disposal, Inkjet Cartridges	18		
Docking Station, Ink Cartridge	2		
E			
ENTER Key	3, 11		
Exit Guides	1		
F			
FAULT Indicator	3		
Features Tab	12		
Feed Rollers			
Cleaning	21		
Remove/Replace	20		
Feed, Set-Up	6		
Forwarding Rollers, Cleaning	21		
Fuse			
Main Power	2		
G			
Guides			
Exit	1		
Rear Media	1, 2		
Side	2		
H			
Hardware, Optional	26		
I			
Inkjet Cartridges			
Disposal	18		
Docking Station	2		
Install	6		
Maintenance	17		
Remove/Replace	17		
Storage	18		
Troubleshooting	23		
Install			
Inkjet Cartridges	6		
Printer	5		
Printer Driver	7		
Inverse Printer	14		
J			
Jams, Printer	19		
M			
Main Power Fuse	2		
Main Power Switch	2		
Maintenance	17		
Cleaning	21		
Feed Rollers	20		
Inkjet Cartridges	17		
Sheet Separators	19		
Media Sensor	1		
Cleaning	21		
Media Thickness Control	3		
MENU Key	3, 9		
Microsoft Word	15		
Motor Circuit Breaker	2		
O			
ON LINE Key	3, 11		
P			
Paper Tab	14		
Parallel Port	2		
Power Receptacle	2		
Print Heads Tab	13		
Printer			
Circuit Breaker	2		
Cleaning	21		
Connecting	5		
Control Panel	1, 3		
Docking Station	2		
Install	5		
Jams	19		
Main Power Switch	2		
Maintenance	17		
Media Sensor	1		
Media Thickness Control	3		
Operating	9		
Parallel Port	2		

INDEX

Power Receptacle	2
Printhead Assembly	1
Purge	11
Rear Media Guide	1, 2
Rear Media Support	1, 2
Sheet Separators	19
Side Guides	2
Specifications	25
Supplies & Hardware	26
Troubleshooting	23, 24
USB Port	2
Printer Driver	
Features Tab	12
Install	7
Paper Tab	14
Print Heads Tab	13
Properties	11
Printhead	
Assembly	1
Cleaning	18
Safety Cover	1
Purge	11
R	
Rear Media Guide	1, 2
Rear Media Support	1, 2
Remove/Replace	
Inkjet Cartridges	17
RESET Key	3, 11
S	
Safety Cover, Printhead	1
Set-Up	
Feed	6
Microsoft Word	15
Sheet Separators	
Maintenance	19
Specifications	25
Storage, Inkjet Cartridges	18
Supplies, Printer	26
T	
TEST Key	9
TEST PRINT Key	3
Troubleshooting	23
Inkjet Cartridges	23
Printer	24
U	
USB Port	2

Copyright © 2015 **ASTRO MACHINE CORP.**
Elk Grove Village, IL 60007
04/02/2015

Part Number: 200-AJ2650/2800PCL Rev. E
